

### Colección Faz / Faz Collection Instrucciones para montaje / Assembling instructions

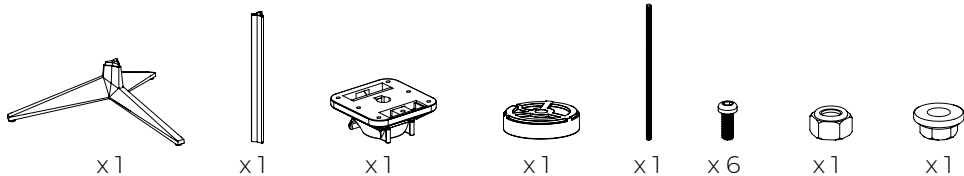

Soporte Abatible  
Folding Mechanism

! Tuerca Autoblocante M10  
M10 Self-locking Nut

Disco Adaptador  
Disk Adapter

Varilla Roscada M10  
M10 Threaded Rod

Tubo  
Tube

Base  
Base

! Tuerca con Collar M10  
M10 Flange Nut  
Nº 17 Hexagonal Wrench

Soporte Abatible  
Folding Mechanism

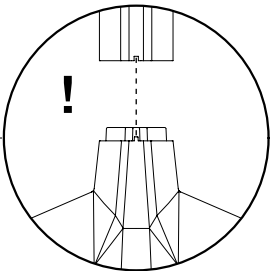
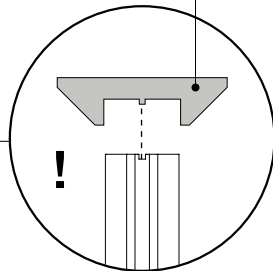

Pata de Nivelación  
Leveling leg piece

## ASSEMBLY



Llave Allen N° 4  
N° 4 Allen Key



M6 x 18 mm  
M6 x 18 mm  
x 6

Posiciones de los Tornillos en Tableros Cuadrados y Redondos  
Screw Insertions in Square and Round Table Top

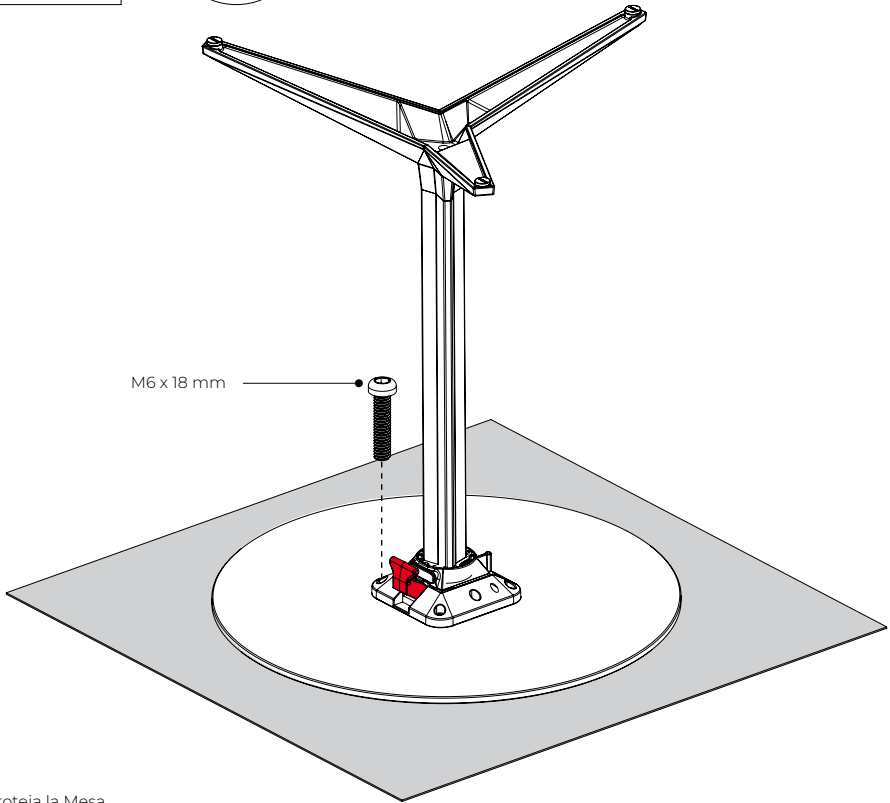
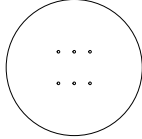
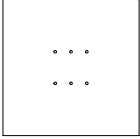

M6 x 18 mm



Proteja la Mesa  
Please make sure the table top is well looked after

50 cm  
19 3/4"

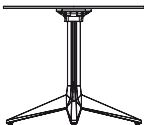

54125T

73 cm  
28 3/4"

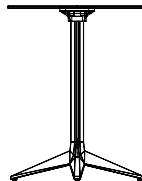

54126T

105 cm  
41 3/4"

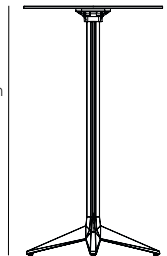

54127T