

Frame ottoman

by Ramón Esteve

Frame, outdoor collection by Ramon Esteve, comes from generating serene and timeless shapes using the framework as elementary geometry. The endless possibilities offered by the material using advanced technology, was the motivation to explore the limits.



Info

Description

Made of polyethylene resin by rotational moulding. 100% Recyclable. Item suitable for indoor and outdoor use. Available in different finishes.

Weight: 18.9 Kg

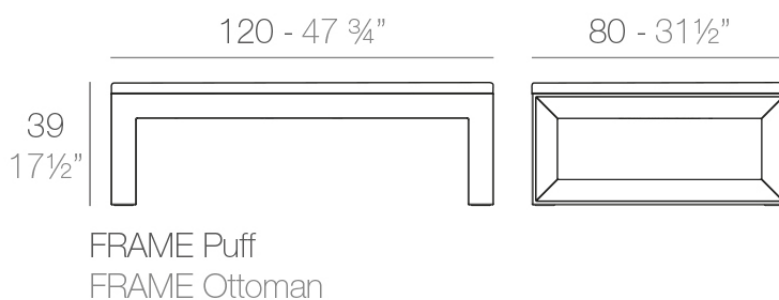

Finishes

finishes

BASIC

Ref. 54102



orange



notte blue



crema

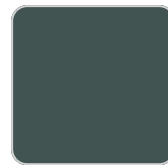

green



purjai red



white



black



steel



red



khaki



taupe



ecru



beige

Matt Polyethylene

LACQUERED

Ref. 54102F



orange



notte blue



crema



purjai red

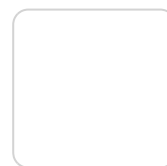

white

VONDOM



black



steel



red



khaki



taupe



ecru



beige



modo green



bronze



anthracite



champany

Lacquered Polyethylene

fabric

NAUTIC
Ref. 54102CO



crema 1103



red 1108



steel 1101

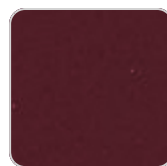

purjai red 1106



black 1105



notte blue 1114



taupe 1102

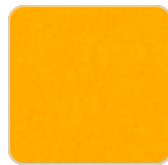

orange 1113



bronze 1104

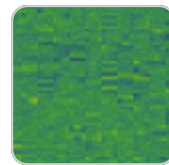

forest 1112

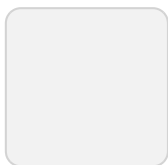

white 1100

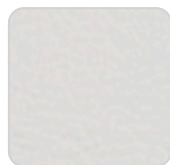

natural 1111

VONDOM

Soft leather like fabric suitable for indoor and outdoor use. Standard option for upholstery.

SILVERTEX Ref. 54102CO

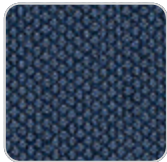

notte blue 1222

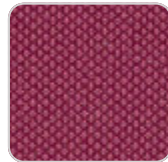

purjai red 1223



ecru 1221



natural 1220



white 1219



forest 1224



bronze 1214



khaki 1218



steel 1208



taupe 1209



antrachite 1210

Vinyl fabric suitable for indoor and outdoor use. Special option for upholstery.

CREVIN Ref. 54102CO



melon 1304



lemongrass 1303



deep blue 1302



blue 1301



white 1308



steel 1309



taupe 1310

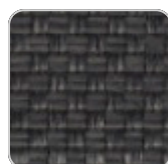

anthracite 1311

VONDOM

Upholstery fabric, that as and natural appearance and can be easy cleaned by washing machines, allowing an easy removal of mildew. Suitable for indoor and outdoor use

CICO

Ref. 54102CO



sandstone 1703



gravel 1702



limestone 1701



cranberry 1707



blueberry 1706



onyx 1705



greywacke 1704

Cozy fabric with an elegant look and soft touch.

ACAPULCO

Ref. 54102CO

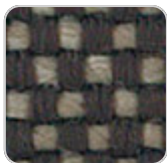

acapulco 1804



acapulco 1803



acapulco 1802



acapulco 1801



acapulco 1806



acapulco 1805

Cozy fabric with an elegant look and soft touch.

VONDOM

SIESTA

Ref. 54102CO



siesta 1812



siesta 1811



siesta 1810



siesta 1813

Cozy fabric with an elegant look and soft touch.

IKON

Ref. 54102CO



ikon 1835



ikon 1834



ikon 1833



ikon 1832

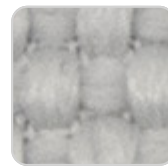

ikon 1831



ikon 1830

Cozy fabric with an elegant look and soft touch.

HERITAGE

Ref. 54102CO



papyrus 1530



granite 1531

Outdoor fabrics are waterproof 50% recycled acrylic, 47% acrylic and 3% PE.

SAVANE

Ref. 54102CO

VONDOM



tornado 1503

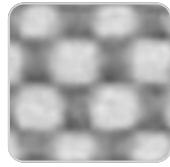

whisper 1502



white 1501

Outdoor fabrics are waterproof 100% acrylic.

