

## Milos sun lounger

by Jean-Marie Massaud

The Milos collection is the fruit of **Vondom's first collaboration with French designer Jean-Marie Massaud**. An example of how simplicity and functionality can be combined to create an elegant and comfortable outdoor furniture collection. Characterised by soft curves, this collection focuses on comfort.



## Info

---

### Description

The sun lounger from the Milos collection harmoniously combines functionality and beauty. Precision manufactured, this sun lounger features a lacquered aluminium structure that ensures exceptional resistance to outdoor conditions.

Its iroko wood legs add a touch of elegance and warmth, while providing stability and a connection to nature.

Weight: 33 Kg

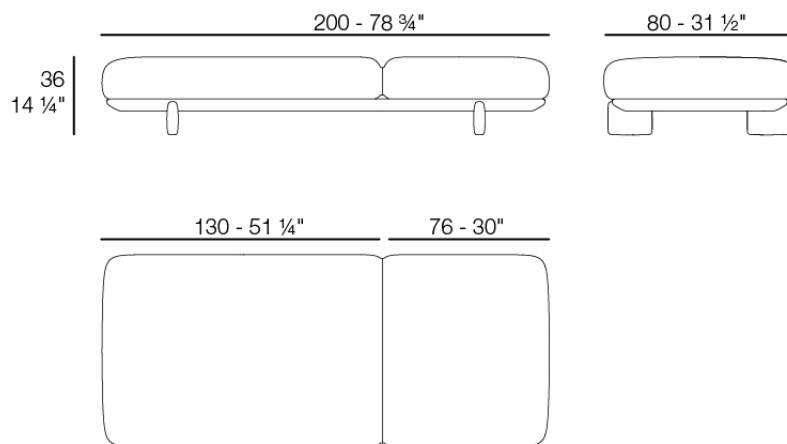

MILOS Tumbona  
MILOS Sun Chaise  
Ref. 70013

## Finishes

---

### finishes

---

POLYURETHANE

Ref. 70013

Furniture made of flexible polyurethane injected cold. This material possesses a high resilience and durability.

### fabric

---

GLAD

Ref. 70013CO



oro 1031



ocre 1051



sunset 1020



delhi 1038



lima 1030



aguacate 1028

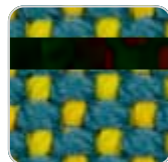

caribe 1004

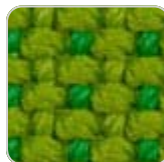

bosc 1029

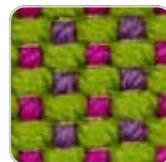

artemisa 1027

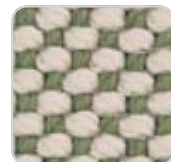

oasis 1007



oceano 1005



pruna 1045



noa 1026



berry 1021



amatista 1011

# VONDOM

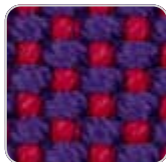

vera 1019



afrodita 1013



grana 1046



bacco 1034



dahlia 1035



wine 1012



foc 1052

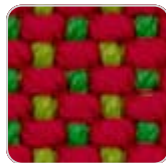

hestia 1014



turquoise 1053

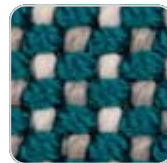

niord 1015



masai 1018

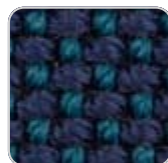

ultramar 1002



aquamarina 1003



esmeralda 1016

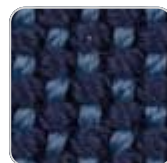

night 1024

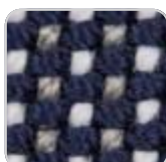

galan 1025

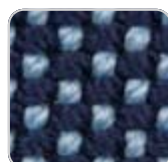

eclipse 1023

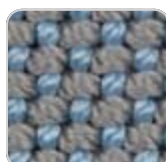

perla 1006



calipso 1017



snow 1041



iceberg 1037



steel 1042



moon 1040



granito 1008



grey 1043



anthracite 1044

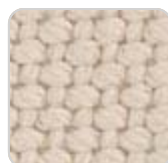

ecru 1047



dessert 1033



taupe 1048



terra 1039



duna 1009



moka 1010



chocolate 1050

Soft and cozy fabric suitable for indoor and outdoor use.

VARM



# VONDOM

Ref. 70013CO



purjai+crema 1065



green+crema 1064



crema+blue 1063



blue jeans 1071



crema+gray 1062



tortora+crema 1070



purjai red 1069

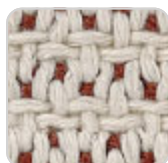

crema+ purjai red  
1061

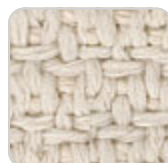

crema 1068

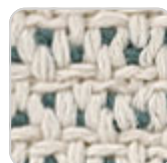

crema+modo green  
1060



blue+crema 1067



black+crema 1066

Soft and cozy fabric suitable for indoor and outdoor use.

## HYGGE

Ref. 70013CO

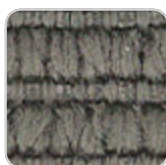

gray 1081



crema 1080



blue 1083



black 1082

Soft and cozy fabric suitable for indoor and outdoor use.

## KROLLET

Ref. 70013CO

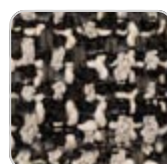
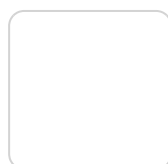
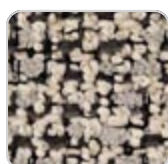
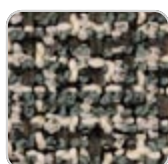
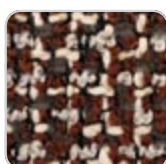

# VONDOM

krollet purjai 1924

krollet verde 1923

krollet crema 1922

krollet white 1921

krollet black 1926



krollet blue notte 1925

Soft and cozy fabric suitable for indoor and outdoor use.

## Ambients

---

