

## Quartz dining table ø90

by Ramón Esteve

The Quartz chairs and table collection, designed by Ramón Esteve for Vondom, is characterized by its **orthogonal geometry and triangular shaped profiles**. Due to the line of one of its vertexes this piece appears extremely light.



## Info

---

### Description

Made from polypropylene and reinforced with fiberglass manufactured by gas injection. Available in various colors. Suitable for indoor and outdoor use.

Weight: 10.8 Kg

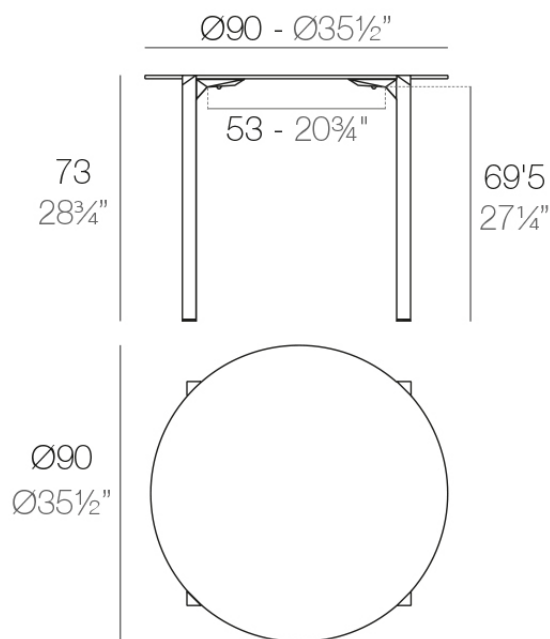

QUARTZ Mesa Ø90  
QUARTZ Table Ø35 1/2"

## Finishes

---

### finishes

---

BASIC PP  
Ref. 54201



white



black



ecru

Available in various colors

### tabletops

---

Solid Core  
Ref. VVAR02351

HPL  
Ref. VVAR02351

HPL black edge

Solid Core wood  
Ref. VVAR02351

## tabletops

---

### Solid Core

Ref. VVAR02351



traffic gray



crema



yule brown



castoro fiber

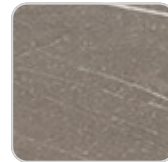

pulpis gray

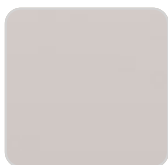

piombo gray

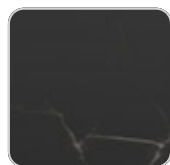

kandia black



cacao

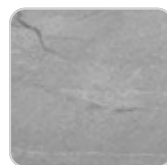

yule gray



modo green



gioia bianco



purjai red



british gray



notte blue

### HPL

Ref. VVAR02351

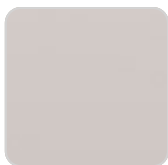

ecru(black edge)

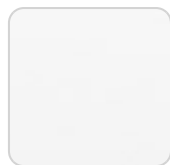

white(black edge)



black(black edge)

### HPL black edge

### Solid Core wood

Ref. VVAR02351

# VONDOM



oak1



oak2

