

Vela table 200x100x72

by Ramón Esteve

Vela Collection, designed by Ramon Esteve for Vondom. This extensive outdoor furniture and plantpot collection aims to offer the comfort and the quality of interior furniture without losing it's original qualities.



Info

Description

Made of polyethylene resin by rotational moulding. 100% Recyclable. Item suitable for indoor and outdoor use. Available in different finishes.

Weight: 82.85 Kg

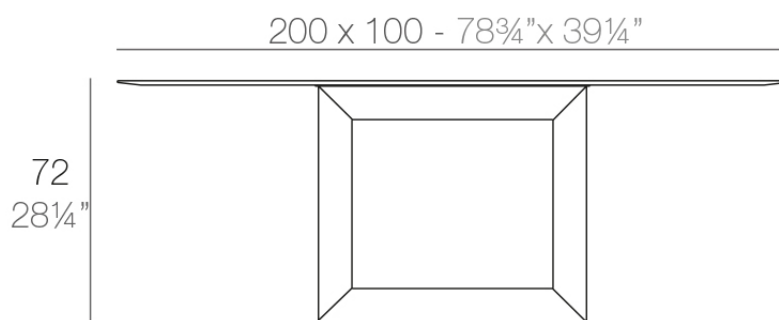

VELA Mesa
VELA Table

Finishes

finishes

BASIC

Ref. 54050FG

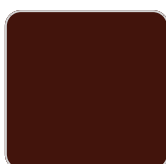

purjai red



crema



green



orange



notte blue



ice



white



black



bronze



steel



anthracite



champany



red



khaki

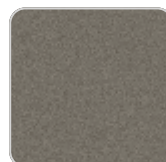

taupe



VONDOM

ecru



beige



Matt Polyethylene

LACQUERED

Ref. 54050F



purjai red



crema



orange



notte blue

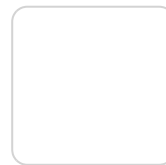

white



black



bronze



steel



anthracite



champany



red



khaki



taupe



ecru



beige



modo green



Lacquered Polyethylene

lighting

WHITE LED
Ref. 54050W



ice



White internally lit unit with LED technology. Available only in matte ice white finish.

RGBW LED
Ref. 54050L

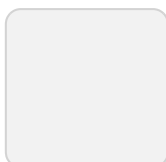

ice



Unit with internal lighting with RGBW LED technology and remote control unit for switching colors. Available only in matte ice white finish. Remote control included.

RGBW LED DMX Ref. 54050D



Unit with internal lighting with RGBW LED technology and remote control unit for switching colors. Also controlled by DMX-1024 (wireless), enabling communication between one or more products simultaneously via the DMX transmitter (not included). There are two options to choose from: Professional XLR DMX and Home WIFI DMX. (Remote control included).
Optional battery

RGBW LED BATTERY Ref. 54050Y



Unit with internal lighting with battery-powered RGBW LED technology. Includes charger and remote control for switching colors and charger. Available only in matte ice white finish.

RGBW LED DMX BATTERY Ref. 54050DY

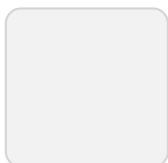

Unit with internal lighting with RGBW LED technology and remote control unit for switching colors. Also controlled by DMX-1024 (wireless), enabling communication between one or more products simultaneously via the DMX transmitter (not included). There are two options to choose from: Professional XLR DMX and Home WIFI DMX. (Remote control included).

tabletops

HPL

Ref. VVAR02176



black(black edge)

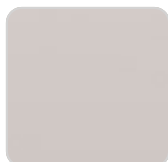

ecru(black edge)

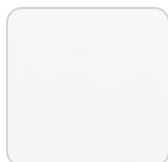

white(black edge)



HPL black edge

Ambients

