

Products / Planters / Venus Planter ø125x120

Venus planter ø125x120

by Marcel Wanders

Venus Collection, designed by Marcel Wanders for Vondom. This curvaceous vase adds character to any surrounding.



Info

Description

Weight: 36.02 Kg

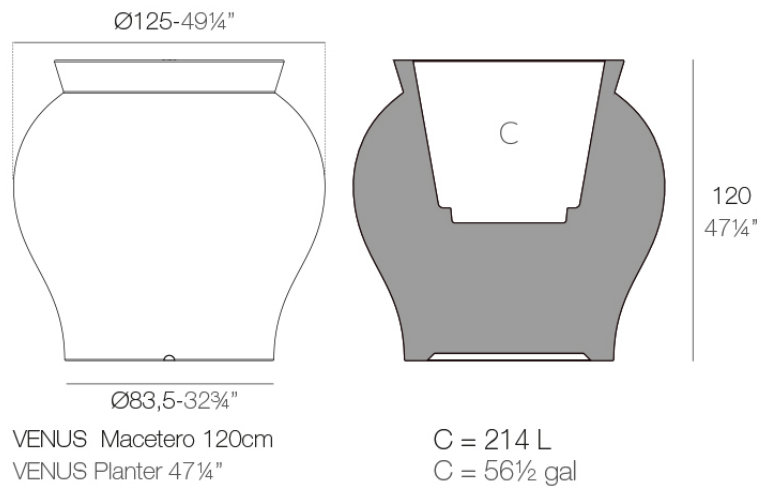

Finishes

finishes

SELF-WATERING

Ref. 67020R



orange

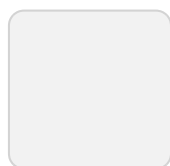

ice



notte blue



crema



green



purjai red

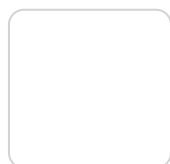

white



black

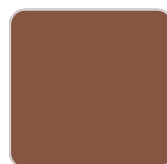

bronze

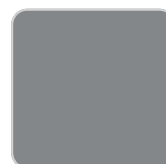

steel



anthracite

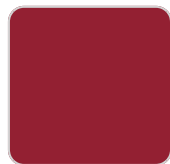

red



khaki



taupe



ecru

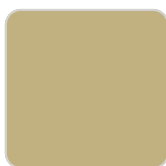

beige

Self-watering system included in all planters except those with basic finish

LACQUERED

Ref. 67020RF



purjai red



white



black



bronze



steel



anthracite



red



khaki



taupe



ecru



beige



modo green



champany

Lacquered Polyethylene

lighting

LIGHT

Ref. 67020W

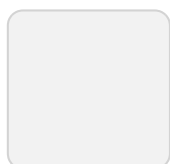

ice

White internally lit unit with LED technology. Available only in matte ice white finish.

RGBW LED

Ref. 67020L

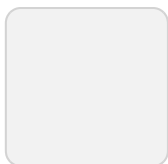

ice

Unit with internal lighting with RGBW LED technology and remote control unit for switching colors. Available only in matte ice white finish. Remote control included.

RGBW LED DMX

Ref. 67020D

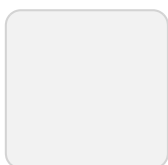

ice

Unit with internal lighting with RGBW LED technology and remote control unit for switching colors. Also controlled by DMX-1024 (wireless), enabling communication between one or more products simultaneously via the DMX transmitter (not included). There are two options to choose from: Professional XLR DMX and Home WIFI DMX. (Remote control included). Optional battery

RGBW LED BATTERY

Ref. 67020Y

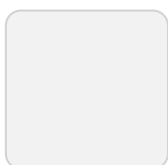

ice

Unit with internal lighting with battery-powered RGBW LED technology. Includes charger and remote control for switching colors and charger. Available only in matte ice white finish.

RGBW LED DMX BATTERY

Ref. 67020DY

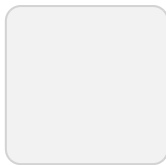

ice

Unit with internal lighting with RGBW LED technology and remote control unit for switching colors. Also controlled by DMX-1024 (wireless), enabling communication between one or more products simultaneously via the DMX transmitter (not included). There are two options to choose from: Professional XLR DMX and Home WIFI DMX. (Remote control included).

Ambients

