

Products / Planters / Venus Planter ø 62x60

Venus planter ø 62x60

by Marcel Wanders

Venus Collection, designed by Marcel Wanders for Vondom. This curvaceous vase adds character to any surrounding.



Info

Description

Weight: 36 Kg

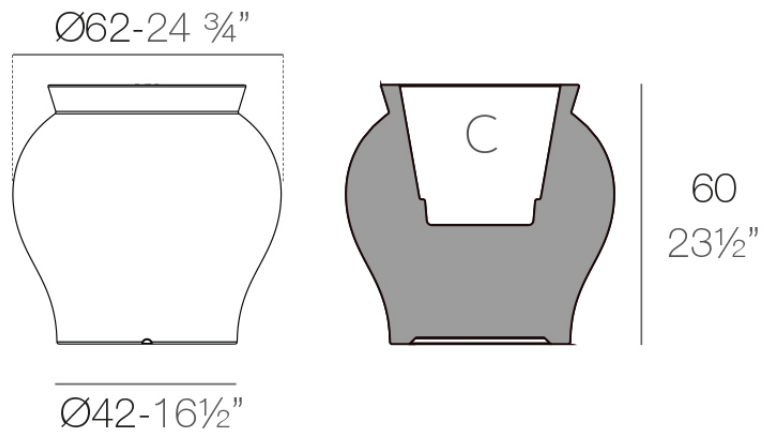

VENUS Macetero 60 cm

C = 25 L

VENUS Planter 23 1/2"

C = 6 1/2 gal

Finishes

finishes

BASIC

Ref. 67020A



orange



notte blue

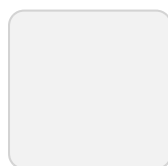

ice



crema



green



purjai red



white



black



bronze



steel



anthracite



red



khaki



taupe



ecru



beige

Matt Polyethylene

SELF-WATERING

Ref. 67022R



orange



notte blue

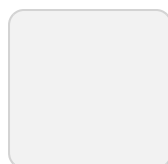

ice

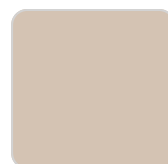

crema



green



purjai red

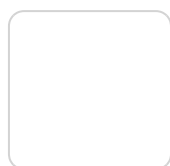

white



black

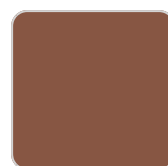

bronze



steel



anthracite



red



khaki



taupe



ecru

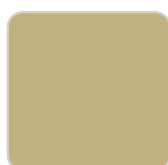

beige

Self-watering system included in all planters except those with basic finish

LACQUERED

Ref. 67022RF



purjai red

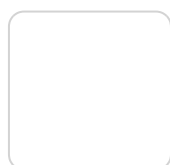

white



black



bronze



steel



anthracite



red



khaki



taupe



ecru



beige

modo green

champany

Lacquered Polyethylene

lighting

LIGHT

Ref. 67022W

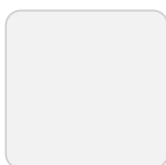

ice

White internally lit unit with LED technology. Available only in matte ice white finish.

RGBW LED DMX

Ref. 67022D

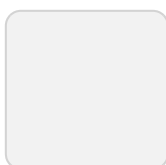

ice

Unit with internal lighting with RGBW LED technology and remote control unit for switching colors. Also controlled by DMX-1024 (wireless), enabling communication between one or more products simultaneously via the DMX transmitter (not included). There are two options to choose from: Professional XLR DMX and Home WIFI DMX. (Remote control included). Optional battery

RGBW LED BATTERY

Ref. 67022Y

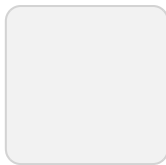

ice

Unit with internal lighting with battery-powered RGBW LED technology. Includes charger and remote control for switching colors and charger. Available only in matte ice white finish.

RGBW LED DMX BATTERY

Ref. 67022DY

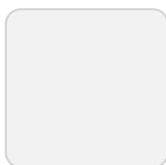

ice

Unit with internal lighting with RGBW LED technology and remote control unit for switching colors. Also controlled by DMX-1024 (wireless), enabling communication between one or more products simultaneously via the DMX transmitter (not included). There are two options to choose from: Professional XLR DMX and Home WIFI DMX. (Remote control included).

Ambients

