

Products / Planters / Venus Planter ø 83x80

# Venus planter ø 83x80

by Marcel Wanders

Venus Collection, designed by Marcel Wanders for Vondom. This curvaceous vase adds character to any surrounding.



# Info

---

## Description

Weight: 16.02 Kg

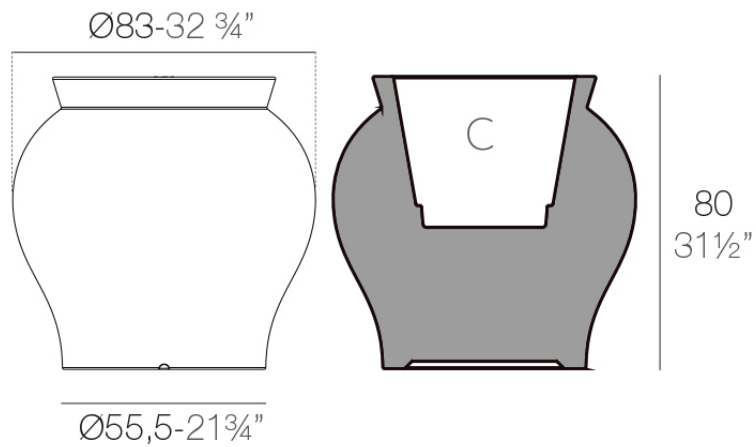

VENUS Macetero 80 cm  
VENUS Planter 31 1/2"

C = 58 L  
C = 15 1/4 gal

# Finishes

---

## finishes

---

### BASIC

Ref. 67021A



orange



notte blue

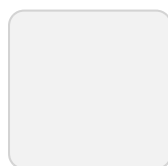

ice



crema



green



purjai red



white



black



bronze



steel



anthracite



red



khaki



taupe

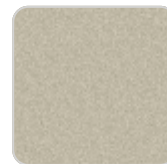

ecru



beige

### Matt Polyethylene

### SELF-WATERING

Ref. 67021R



orange



notte blue



ice

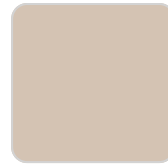

crema

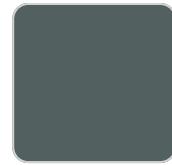

green



purjai red



white



black

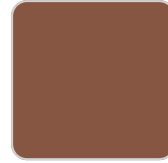

bronze

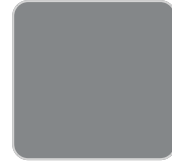

steel



anthracite



red



khaki

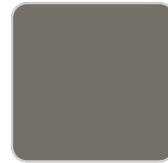

taupe



ecru



beige

Self-watering system included in all planters except those with basic finish

## LACQUERED Ref. 67021RF



purjai red



white



black



bronze



steel



anthracite



red



khaki



taupe



ecru



beige

modo green

champany

Lacquered Polyethylene

## lighting

---

### LIGHT

Ref. 67021W

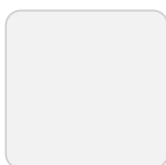

ice

White internally lit unit with LED technology. Available only in matte ice white finish.

### RGBW LED DMX

Ref. 67021D

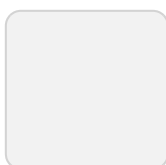

ice

Unit with internal lighting with RGBW LED technology and remote control unit for switching colors. Also controlled by DMX-1024 (wireless), enabling communication between one or more products simultaneously via the DMX transmitter (not included). There are two options to choose from: Professional XLR DMX and Home WIFI DMX. (Remote control included). Optional battery

### RGBW LED BATTERY

Ref. 67021Y

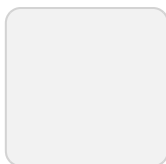

ice

Unit with internal lighting with battery-powered RGBW LED technology. Includes charger and remote control for switching colors and charger. Available only in matte ice white finish.

## RGBW LED DMX BATTERY

Ref. 67021DY

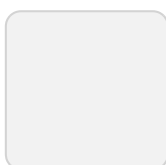

ice

Unit with internal lighting with RGBW LED technology and remote control unit for switching colors. Also controlled by DMX-1024 (wireless), enabling communication between one or more products simultaneously via the DMX transmitter (not included). There are two options to choose from: Professional XLR DMX and Home WIFI DMX. (Remote control included).

# Ambients

---

